

MEDIDEN

CAD / CAM Dental Solutions

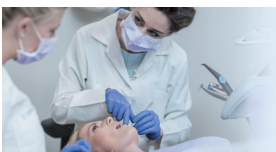

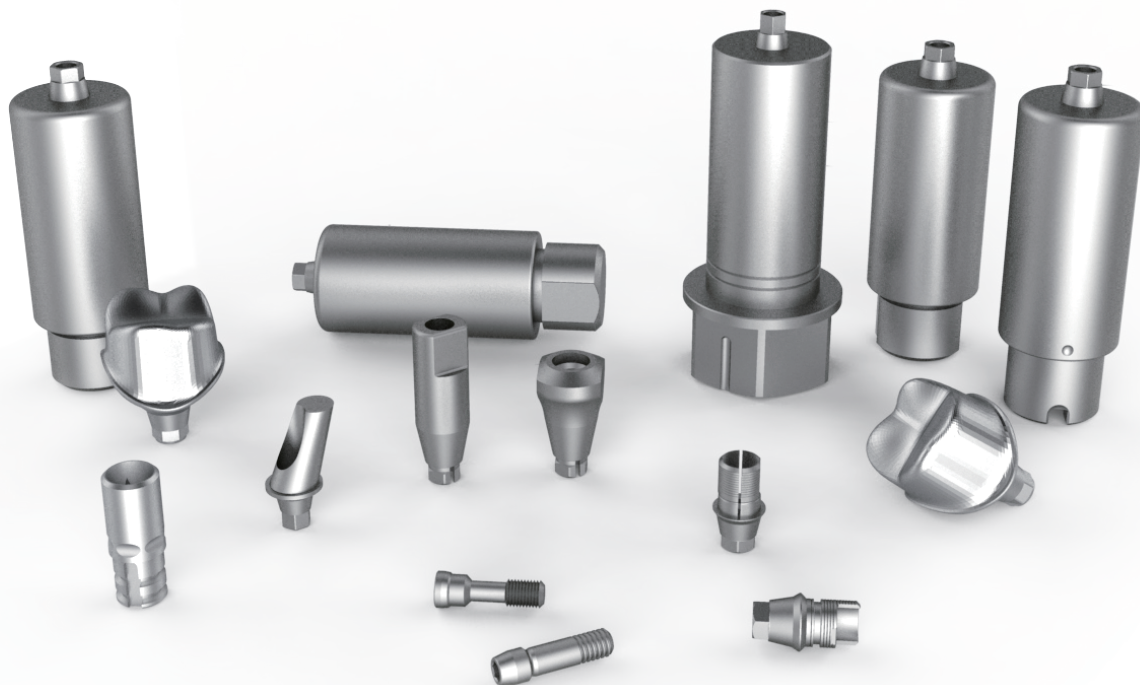

Contents

03	Company History
04	Dental System Workflow
05	Screw
06	Lab Driver Set
07	Scanbody
08	Lab Analog
09	Link Abutment
10	Premill Abutment
11	Dental Machines
12	Dental Machines
13	Dental Milling Tool
14	Dental Milling Tool
15	Dental Milling Tool
16	Dental Milling Tool
17	Dental Milling Tool
18	Product List
19	Product List

Company history

Since 2010, we have been dedicated to research and development of the dental implant system and in 2015, with our extensive experiences and know-how, MEDiDEN was founded.

MEDiDEN is now working on to achieve a zero defect rate by inspecting every single product of ours through the all hand inspection in order to deliver only the best quality.

With consistent efforts on research and development, we are trying to offer only the very best products and services to contribute to the healthier and happier life of our customers.

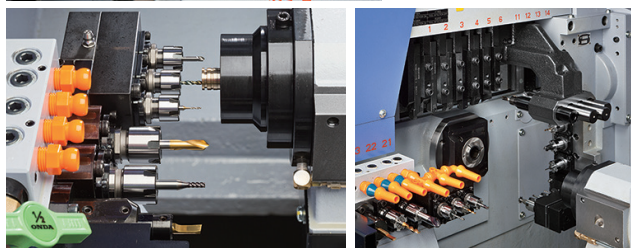
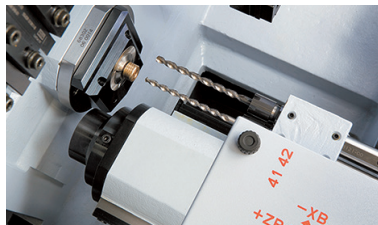

Dental System Workflow

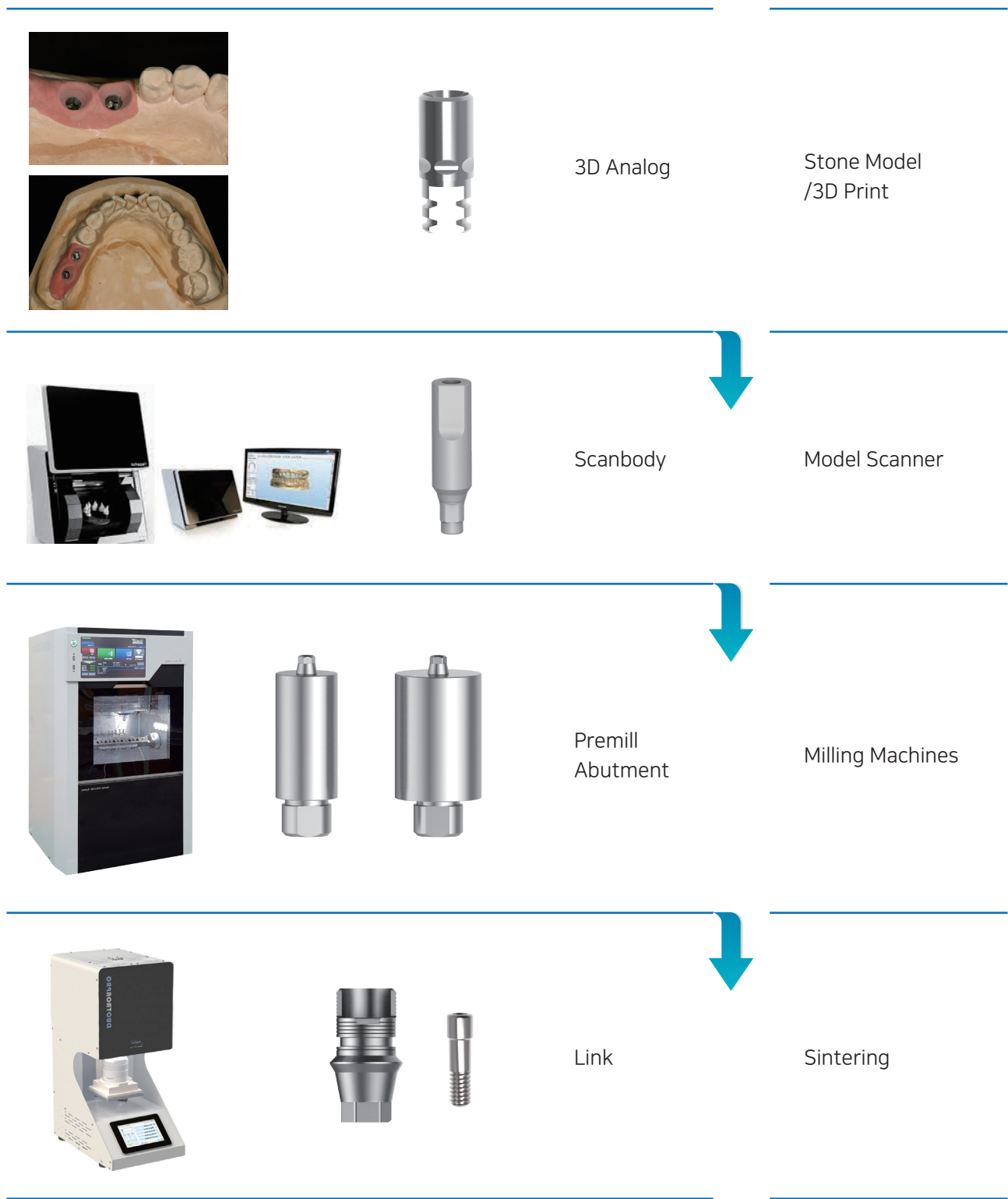









Screw



Raw Material

Ti6AL-4V ELI(ASTM F136)
Supplied by USA

- All hand inspection
- High precise result and quality









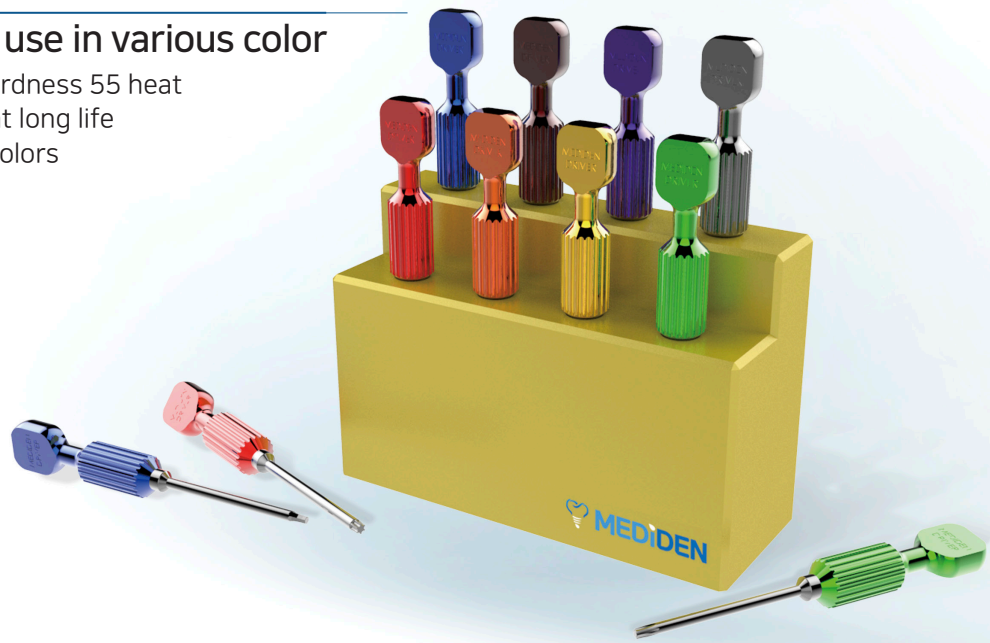

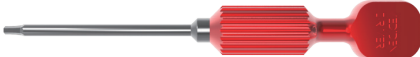

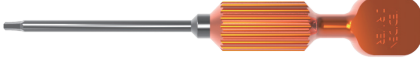

SIZE	IMPLANT SYSTEM
HEX1.2	 BIOMET 3I - External / Certain , COWELLMEDI - Inno Internal , DENTIS - i-Clean , DENTSPLY - Xive DIO - UF , MEGAGEN - Anyone / Anyridge / EZ Plus , NEOBIOTECH - IS , OSSTEM - GS / US / SS SHINHUNG , WARANTEC - Oneplant , GLOBAL D
HEX 1.25	 BIOHORIZONS , DENTIS - S-Clean , KEYSTONE - Prima , LASAK - Bioniq , VEGO - Semados
HEX 1.27	 ADIN - Touareg , ALPHABIOTEC - Internal Hex , ANTHOGYR , ASTRA TECH , CAMLOG , CORTEX C-TECH - Esthetic Line , DEEP , DENTIUM - Super line / Simple line , EBI IMPLANT DIRECT - Legacy , MIS - C1 / Internal Hexagon , ZIMMER - Tapered Screed-Vent
HEX 1.3	 ASTRA TECH - EV , DYNA , KENTEC
S-TORX	 STRAUMANN - Bone Level / Synocta / Conical Bone Level
N-Torx	 ADIN - Closefit , NOBEL BIOCARE - Active / Branemark / Replace
SQUARE	 DENTIUM - NR Line
D-TORX	 DIO - SM

Lab Driver Set

Easy to use in various color

- Brinell hardness 55 heat
- treatment long life
- Various colors

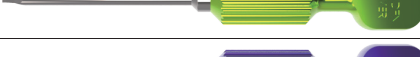

SIZE	SHAPE	IMAGE	COLOR	RECOMMENDED TORQUE
Hex 1.2			Red	20
Hex 1.25			Orange	30
Hex 1.27			Yellow	30
Hex1.3			black	30
S-Torx			Green	35
D-Torx			Blue	35
Square			Yellow Green	20
N-Torx			Purple	35

Scanbody

No shaking of double hexa structure

Present the exact position and orientation of the implant
create accurate scan data with SLA surface processing

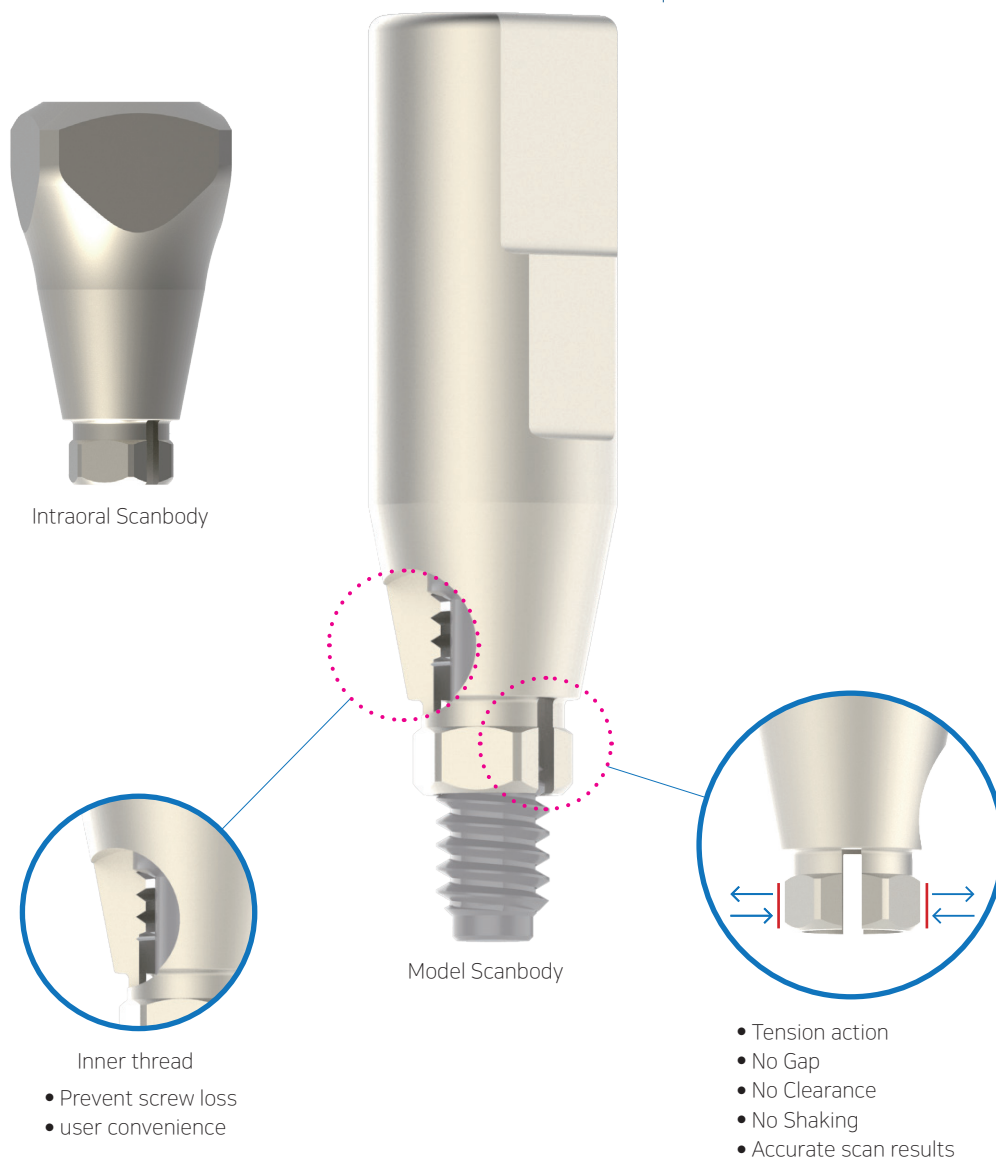

Lab Analog

Raw material

Stainless steel 303F

- 3D Print model
- Plaster model

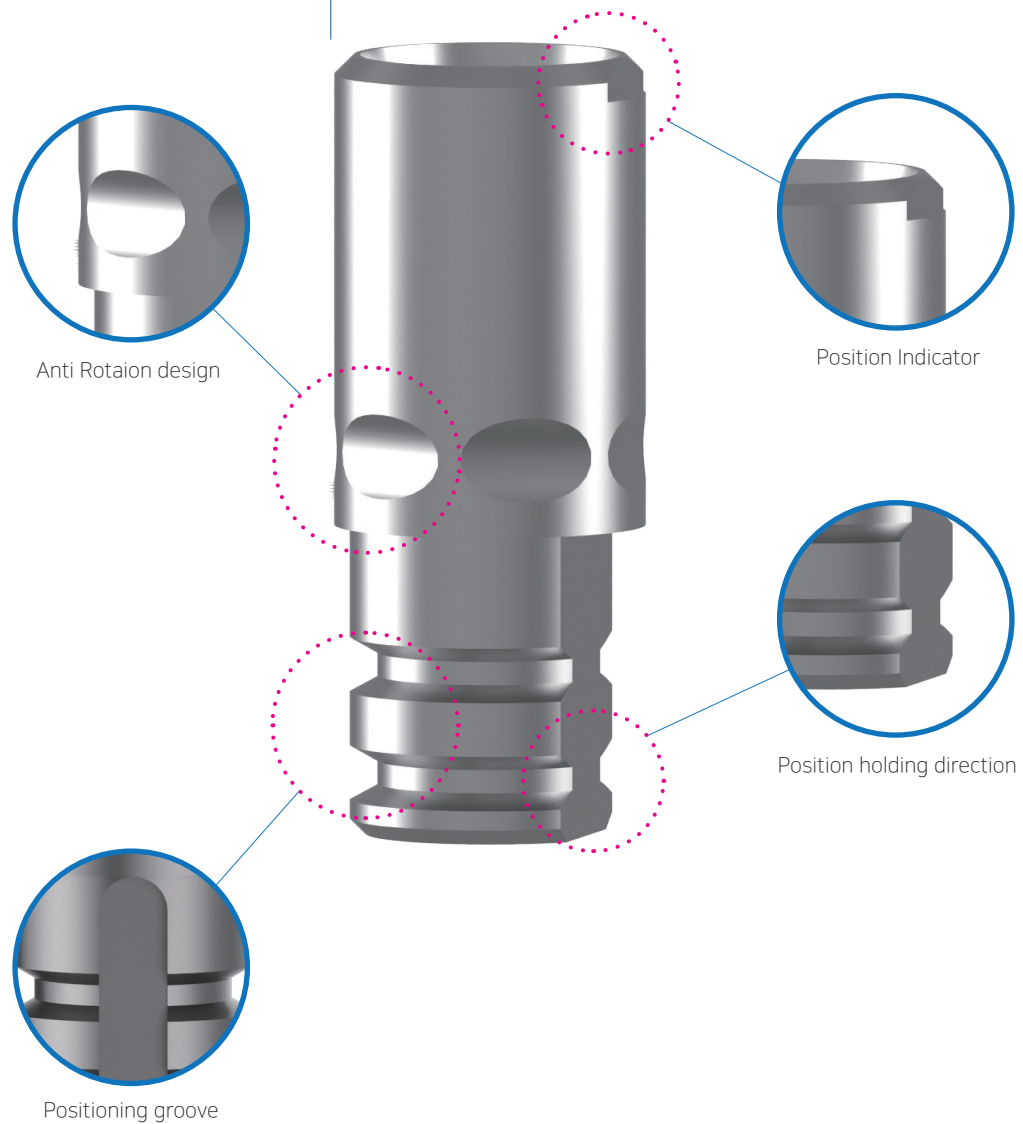

Link Abutment

Raw material

Ti6AL-4V ELI(ASTM F136)
Supplied by USA

- No Cement
- No Gap
- Minimize the risk of crown fracture

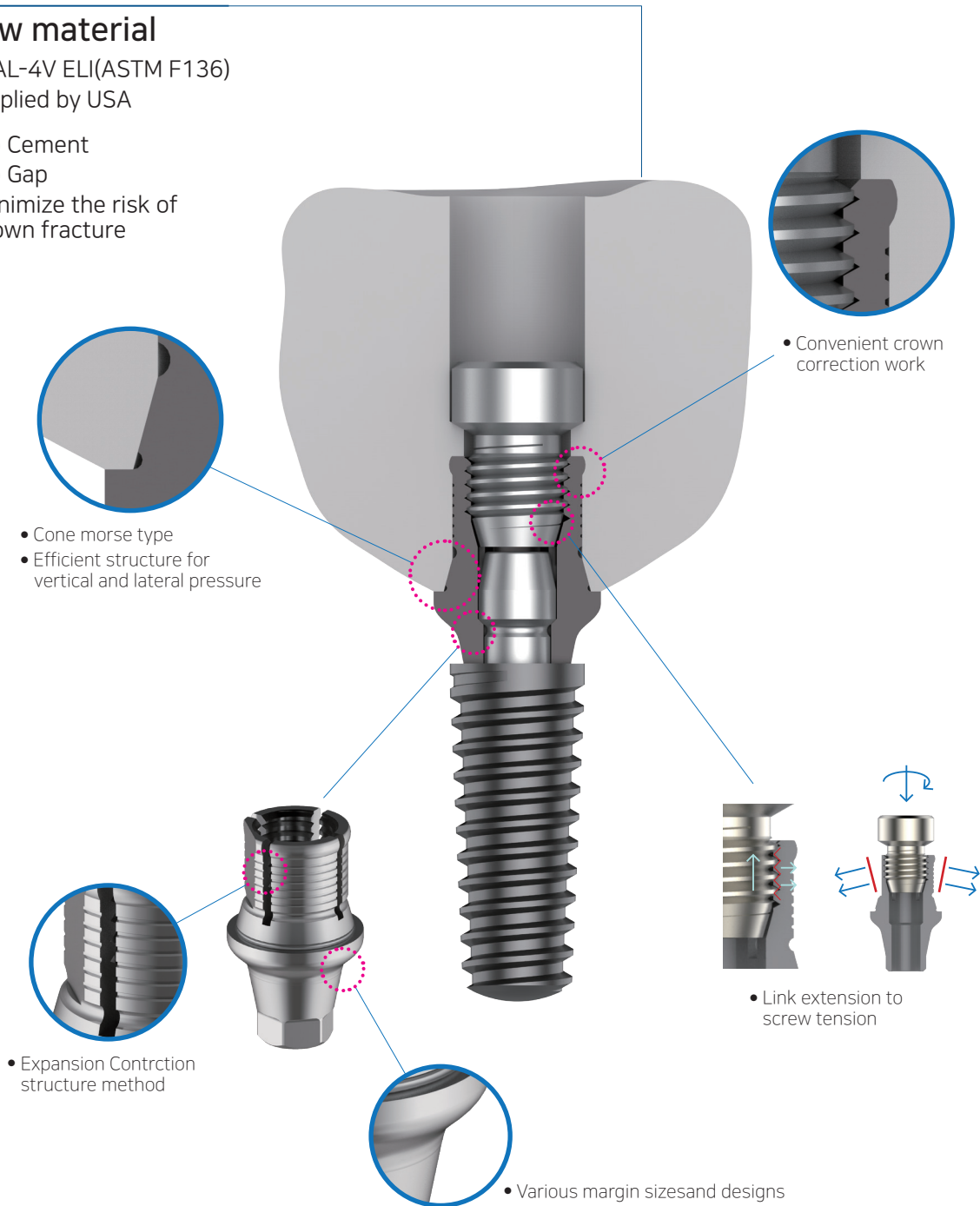

Premill Abutment

Raw Material

Ti6AL-4V ELI (ASTM F136)
Supplied by USA

2 type of diameter, $\varnothing 10$ and $\varnothing 14$
wide range of products
All hand inspection

- Precision machined up to $\pm 5\mu$
- High precise result and quality



Dental Machines PM5

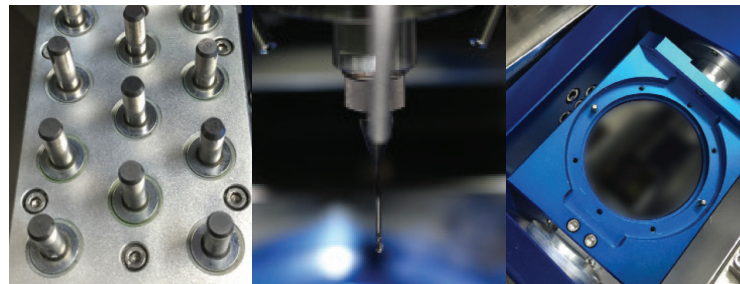

Specifications

M/C name	PM5
Size(mm) (Width×Height×Depth)	M/C 600×680×640 Addition 600×760×640 (Total 600×1560×640)
Axis	5-Axis
Manufacturable Material	Metal/Zirconia/PMMA/WAX/ Glass Ceramic/Abutment/ETC
Spindle	1.8~2.7kw/60,000RPM Air Cooling
Accuracy	± 1μm
Endmill(∅)	Metal 0.5/1.0/1.5/2.0/3.0 Zirconia 0.3/0.5/1.0/2.0 Glass Ceramic 0.6/1.0/2.0 PMMA 0.5/1.0/2.0
Inside System	Cilant + Air Suction
Jig & Material	Disk Cr-Co, Ni Co, Soft Metal, Glass Ceramic, Zirconia, Wax, PMMA, etc Cube Glass Ceramic Abutment Titanium

Dental Machines BX4



Specifications

Specification	Value	Unit
Dimensions (W x D x H)	481 x 529 x 823.5	mm
Weight	75kg	kg
Number of axes	4 axes	-
Type of drive	High Torque Step Motor	-
Guide and screw	X axis : LM guide and ball screw Y axis : LM guide and two ball screws Z axis : LM guide and ball screw	
Moving Range	X axis : 178mm Y axis : 185mm Z axis : 88mm A axis : 360 (Free rotation)	mm mm mm degrees
Spindle	500W High frequency	
Coolant tank capacity	8	liter
Cover / Door	Hood hinged to open downwards	
Required air pressure	5.5 - 8 (continuously applied)	bar
Required air volume	50 ~ 80	L/min
Operating temperature	20 ~ 35	

Dental Milling Tool

ZirkonZahn M5

Company/Model	Out Dia	Overall Length	Shank	Coating
ZirkonZahn M5	D1.0	57	3	No
	D2.0			TIALN
	D0.5			Diamond
	D1.0			
	D2.0			



Wieland / Mini

Company/Model	Out Dia	Overall Length	Shank	Coating
Wieland / Mini	D1.0	35	3	No
	D2.0			
	D2.5			



Wieland / Select

Company/Model	Out Dia	Overall Length	Shank	Coating
Wieland / Select	D0.3	40	3	TIALN
	D0.7			Diamond
	D1.0			
	D2.5			



Katana

Company/Model	Out Dia	Overall Length	Shank	Coating
Katana	D1.0	52	3	No
	D1.3			



* Do not use DK products

Roland

Company/Model	Out Dia	Overall Length	Shank	Coating
Roland WX-51D/DWX-52DC	D0.3	50	4	TIALN
	D0.6			Diamond
	D1.0			
	D3.0			



Cera Cube / Trion-Z

Company/Model	Out Dia	Overall Length	Shank	Coating
Cera Cube/ Trion-Z	D0.5	50	4	TIALN
	D1.0			Diamond
	D2.0			



Dental Milling Tool

RND

Company/Model	Out Dia	Overall Length	Shank	Coating
RND	D0.6	45	4	TIALN
DR100-5Z	D1.0	50		Diamond
	D2.0			
RND	D1.0	45		
DS200-4WA	D1.5	50	6	TIALN/ NACO
	D2.0			
	D3.0			
	D1.5	50(Long)		
	D1.5	50(Flat)		



PRO-DEN

Company/Model	Out Dia	Overall Length	Shank	Coating
PRO-DEN	D0.6	60	6	TIALN
	D1.0			Diamond
	D2.0			

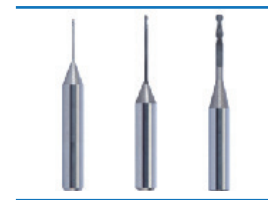

Z-match / CAMEleon

Company/Model	Out Dia	Overall Length	Shank	Coating
Z-match/ CAMEleon	D0.5	55	6	TIALN
	D1.0			Diamond
	D2.0			
Z-match/ CAMEleon TITAN	D1.5	45	6	NACO
	D2.0			
	D3.0			



CAMEleon CS

Company/Model	Out Dia	Overall Length	Shank	Coating
CAMEleon CS	D0.5	40	3	TIALN
	D1.0	Diamond		
	D2.0			



ELBEN/TITAN

Company/Model	Out Dia	Overall Length	Shank	Coating
ELBEN	D0.6	43	6	TIALN
	D1.0			Diamond
	D2.0			
ELBEN/TITAN	D1.0	45	6	TIALN/ NACO
	D2.0			
	D3.0			



DATRON

Company/Model	Out Dia	Overall Length	Shank	Coating
DATRON	D0.6	55	6	TIALN
	D1.0			Diamond
	D2.0			

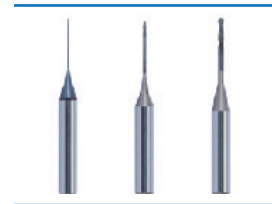

ZirkonZahn M1

Company/Model	Out Dia	Overall Length	Shank	Coating
ZiconZhan M1	D0.5	50	6	NO
	D1.0			
	D2.0			
ZiconZhan M1/ TITAN	D2.0	50	6	NACO
	D3.0			

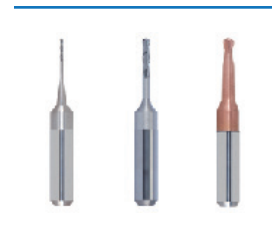

MANIX

Company/Model	Out Dia	Overall Length	Shank	Coating
MANIX ZX-5SD	D0.6	45	4	ALN & NACO
	D1.0			Diamond
	D2.0			
MANIX/ TITAN	D1.5	45	6	NACO
	D2.0			
	D3.0			



Dental Milling Tool

Yena

Company/Model	Out Dia	Overall Length	Shank	Coating
Yenadent	D0.6	45	4	TIALN
	D1.0			Diamond
	D2.0			
Yenadent/ TITAN	D2.0	45	4	TIALN/ NACO
	D3.0			



Sirona

Company/Model	Out Dia	Overall Length	Shank	Coating
sirona/ mc-x5	D0.5	42	3	TIALN
	D1.0	43		Diamond
	D2.5	44		



Rainbow/ Rainbow Mill

Company/Model	Out Dia	Overall Length	Shank	Coating
Rainbow	D1.0	60	6	Diamond
	D2.0			



ARUM

Company/Model	Out Dia	Overall Length	Shank	Coating
ARUM 4X, 5X-10	D0.6	63	6	TIALN
	D1.0			Diamond
	D2.0			
ARUM 4X, 5X-150	D0.5	45	4	TIALN
	D1.0	50		Diamond
	D2.0			
ARUM 4X, 5X-200	D0.6	50	6	TIALN
	D1.0	53		Diamond
	D2.0	55		
ARUM/ TITAN	D1.0	50	6	NACO
	D1.5			
	D2.0			
	D3.0			



AMANN

Company/Model	Out Dia	Overall Length	Shank	Coating
AMANN/ ceremill	D0.6	47	3	TIALN
	D1.0			Diamond
	D2.0			
	D2.5			



**Imes icore_
450i/
340i/
250i**

Company/Model	Out Dia	Overall Length	Shank	Coating
imes icore_450i/ 250i/ 250i dry/ CORITEC one	D0.3	48	3	TIALN
	D0.6			Diamond
	D1.0			
	D2.5			
imes icore_250i/ 450i/ TITAN	D1.0	38.5	3	NACO
	D2.0			
	D3.0			
imes icore_350i, CORITEC 450i(d6)	D1.0	53	6	Diamond
	D2.5			



Charly

Company/Model	Out Dia	Overall Length	Shank	Coating
charly	D0.5	38	3	TIALN
	D1.0			Diamond
	D1.5			
	D2.5			



Vhf

Company/Model	Out Dia	Overall Length	Shank	Coating
vhf S1	D0.6	40	3	TIALN
	D1.0			Diamond
	D2.0			
vhf k4	D0.6	35	3	TIALN
	D1.0			
	D2.0			



Mediden Product List



No	Implant System	Size	Premill-Hex Ø10	Premill-Non Ø10	Premill-Hex Ø14	Premill-Non Ø14	Ti-base Hex	Ti-base Non	3D Analog	Scanbody	Screw
1	Astra EV System	3.0	PA10-H-1	PA10-NH-1	PA14-H-1	PA14-NH-1	TB-H-1	TB-NH-1	3D-A1	SB-A1	S-A1
		3.6	PA10-H-2	PA10-NH-2	PA14-H-2	PA14-NH-2	TB-H-2	TB-NH-2	3D-A2	SB-A2	S-A2
		4.2	PA10-H-3	PA10-NH-3	PA14-H-3	PA14-NH-3	TB-H-3	TB-NH-3	3D-A3	SB-A3	S-A3
		4.8	PA10-H-4	PA10-NH-4	PA14-H-4	PA14-NH-4	TB-H-4	TB-NH-4	3D-A4	SB-A4	S-A4
		5.4	PA10-H-5	PA10-NH-5	PA14-H-5	PA14-NH-5	TB-H-5	TB-NH-5	3D-A5	SB-A5	
2	Astra Tech Osseospeed TX	3.0	PA10-H-6	PA10-NH-6	PA14-H-6	PA14-NH-6	TB-H-6	TB-NH-6	3D-A6	SB-A6	S-A5
		3.5/4.0	PA10-H-7	PA10-NH-7	PA14-H-7	PA14-NH-7	TB-H-7	TB-NH-7	3D-A7	SB-A7	S-A6
		4.5/5.0	PA10-H-8	PA10-NH-8	PA14-H-8	PA14-NH-8	TB-H-8	TB-NH-8	3D-A8	SB-A8	S-A7
3	Bicon Implant	2.0	PA10-H-9	PA10-NH-9	PA14-H-9	PA14-NH-9	TB-H-9	TB-NH-9	3D-A9	SB-A9	S-A8
		2.3	PA10-H-10	PA10-NH-10	PA14-H-10	PA14-NH-10	TB-H-10	TB-NH-10	3D-A10	SB-A10	S-A9
		2.5	PA10-H-11	PA10-NH-11	PA14-H-11	PA14-NH-11	TB-H-11	TB-NH-11	3D-A11	SB-A11	S-A10
		3.0	PA10-H-12	PA10-NH-12	PA14-H-12	PA14-NH-12	TB-H-12	TB-NH-12	3D-A12	SB-A12	S-A11
4	Biohorizons	3.0	PA10-H-13	PA10-NH-13	PA14-H-13	PA14-NH-13	TB-H-13	TB-NH-13	3D-A13	SB-A13	S-A12
5	Biomet 3i Certain	3.4	PA10-H-14	PA10-NH-14	PA14-H-14	PA14-NH-14	TB-H-14	TB-NH-14	3D-A14	SB-A14	
		4.1	PA10-H-15	PA10-NH-15	PA14-H-15	PA14-NH-15	TB-H-15	TB-NH-15	3D-A15		S-A13
		5.0	PA10-H-16	PA10-NH-16	PA14-H-16	PA14-NH-16	TB-H-16	TB-NH-16	3D-A16	SB-A15	
		6.0	PA10-H-17	PA10-NH-17	PA14-H-17	PA14-NH-17	TB-H-17	TB-NH-17	3D-A17		
6	Biomet 3i Osseotite	3.4	PA10-H-18	PA10-NH-18	PA14-H-18	PA14-NH-18	TB-H-18	TB-NH-18	3D-A18	SB-A16	S-A14
		4.1	PA10-H-19	PA10-NH-19	PA14-H-19	PA14-NH-19	TB-H-19	TB-NH-19	3D-A19		
		5.0	PA10-H-20	PA10-NH-20	PA14-H-20	PA14-NH-20	TB-H-20	TB-NH-20	3D-A20	SB-A17	S-A15
		6.0	PA10-H-21	PA10-NH-21	PA14-H-21	PA14-NH-21	TB-H-21	TB-NH-21	3D-A21		S-A16
7	Camlog Implant	3.3	PA10-H-22	PA10-NH-22	PA14-H-22	PA14-NH-22	TB-H-22	TB-NH-22	3D-A22	SB-A18	
		3.8	PA10-H-23	PA10-NH-23	PA14-H-23	PA14-NH-23	TB-H-23	TB-NH-23	3D-A23	SB-A19	S-A17
		4.3	PA10-H-24	PA10-NH-24	PA14-H-24	PA14-NH-24	TB-H-24	TB-NH-24	3D-A24	SB-A20	
		5.0	PA10-H-25	PA10-NH-25	PA14-H-25	PA14-NH-25	TB-H-25	TB-NH-25	3D-A25		S-A18
		6.0	PA10-H-26	PA10-NH-26	PA14-H-26	PA14-NH-26	TB-H-26	TB-NH-26	3D-A26	SB-A21	
8	Dentium NR-Line	3.1/3.6/4.3	PA10-H-27	PA10-NH-27	PA14-H-27	PA14-NH-27	TB-H-27	TB-NH-27	3D-A27	SB-A22	S-A19
9	Dentium Super-Line	universal	PA10-H-28	PA10-NH-28	PA14-H-28	PA14-NH-28	TB-H-28	TB-NH-28	3D-A28	SB-A23	S-A20
10	Dentsply Ankylos	universal	PA10-H-29	PA10-NH-29	PA14-H-29	PA14-NH-29	TB-H-29	TB-NH-29	3D-A29	SB-A24	S-A21
11	Dentsply Xive/Frialit2	3.0	PA10-H-30	PA10-NH-30	PA14-H-30	PA14-NH-30	TB-H-30	TB-NH-30	3D-A30	SB-A25	S-A22
		3.4	PA10-H-31	PA10-NH-31	PA14-H-31	PA14-NH-31	TB-H-31	TB-NH-31	3D-A31	SB-A26	
		3.8	PA10-H-32	PA10-NH-32	PA14-H-32	PA14-NH-32	TB-H-32	TB-NH-32	3D-A32	SB-A27	S-A23
		4.5	PA10-H-33	PA10-NH-33	PA14-H-33	PA14-NH-33	TB-H-33	TB-NH-33	3D-A33		
		5.5	PA10-H-34	PA10-NH-34	PA14-H-34	PA14-NH-34	TB-H-34	TB-NH-34	3D-A34	SB-A28	
12	DIO SM	3.8/4.1	PA10-H-35	PA10-NH-35	PA14-H-35	PA14-NH-35	TB-H-35	TB-NH-35	3D-A35	SB-A29	S-A24
		4.5/5.0	PA10-H-36	PA10-NH-36	PA14-H-36	PA14-NH-36	TB-H-36	TB-NH-36	3D-A36	SB-A30	S-A25
13	DIO UFII	3.0/3.3 (Narrow)	PA10-H-37	PA10-NH-37	PA14-H-37	PA14-NH-37	TB-H-37	TB-NH-37	3D-A37	SB-A31	S-A26
		3.8/4.0/4.5	PA10-H-38	PA10-NH-38	PA14-H-38	PA14-NH-38	TB-H-38	TB-NH-38	3D-A38	SB-A32	S-A27
14	Implant Direct3.0	3.0	PA10-H-39	PA10-NH-39	PA14-H-39	PA14-NH-39	TB-H-39	TB-NH-39	3D-A39	SB-A33	S-A28

No	Implant System	Size	Premill-Hex Ø10	Premill-Non Ø10	Premill-Hex Ø14	Premill-Non Ø14	Ti-base Hex	Ti-base Non	3D Analog	Scanbody	Screw
15	Keystone Prima	3.5	PA10-H-40	PA10-NH-40	PA14-H-40	PA14-NH-40	TB-H-40	TB-NH-40	3D-A40	SB-A34	
		4.1	PA10-H-41	PA10-NH-41	PA14-H-41	PA14-NH-41	TB-H-41	TB-NH-41	3D-A41	SB-A35	
		5.0	PA10-H-42	PA10-NH-42	PA14-H-42	PA14-NH-42	TB-H-42	TB-NH-42	3D-A42		S-A29
		7.0	PA10-H-43	PA10-NH-43	PA14-H-43	PA14-NH-43	TB-H-43	TB-NH-43	3D-A43	SB-A36	
		8.0	PA10-H-44	PA10-NH-44	PA14-H-44	PA14-NH-44	TB-H-44	TB-NH-44	3D-A44		
16	Megagen Anyone	universal	PA10-H-45	PA10-NH-45	PA14-H-45	PA14-NH-45	TB-H-45	TB-NH-45	3D-A45	SB-A37	S-A30
17	Megagen Anyridge	universal	PA10-H-46	PA10-NH-46	PA14-H-46	PA14-NH-46	TB-H-46	TB-NH-46	3D-A46	SB-A38	S-A31
18	Megagen Mini	3.0/3.2	PA10-H-47	PA10-NH-47	PA14-H-47	PA14-NH-47	TB-H-47	TB-NH-47	3D-A47	SB-A39	S-A32
19	MIS C1	3.3	PA10-H-48	PA10-NH-48	PA14-H-48	PA14-NH-48	TB-H-48	TB-NH-48	3D-A48	SB-A40	S-A33
		3.75/4.2	PA10-H-49	PA10-NH-49	PA14-H-49	PA14-NH-49	TB-H-49	TB-NH-49	3D-A49	SB-A41	S-A34
		5.0	PA10-H-50	PA10-NH-50	PA14-H-50	PA14-NH-50	TB-H-50	TB-NH-50	3D-A50	SB-A42	
20	MIS Seven 3.3	3.3	PA10-H-51	PA10-NH-51	PA14-H-51	PA14-NH-51	TB-H-51	TB-NH-51	3D-A51	SB-A43	S-A35
21	NEO IS	3.5/4.0/4.5	PA10-H-52	PA10-NH-52	PA14-H-52	PA14-NH-52	TB-H-52	TB-NH-52	3D-A52	SB-A44	S-A36
22	Nobel Biocare Active	3.0	PA10-H-53	PA10-NH-53	PA14-H-53	PA14-NH-53	TB-H-53	TB-NH-53	3D-A53	SB-A45	S-A37
		3.5	PA10-H-54	PA10-NH-54	PA14-H-54	PA14-NH-54	TB-H-54	TB-NH-54	3D-A54	SB-A46	S-A38
		4.3/5.0	PA10-H-55	PA10-NH-55	PA14-H-55	PA14-NH-55	TB-H-55	TB-NH-55	3D-A55	SB-A47	S-A39
		5.5	PA10-H-56	PA10-NH-56	PA14-H-56	PA14-NH-56	TB-H-56	TB-NH-56	3D-A56	SB-A48	
23	Nobel Biocare Branemark	3.5	PA10-H-57	PA10-NH-57	PA14-H-57	PA14-NH-57	TB-H-57	TB-NH-57	3D-A57	SB-A49	S-A40
		4.1	PA10-H-58	PA10-NH-58	PA14-H-58	PA14-NH-58	TB-H-58	TB-NH-58	3D-A58	SB-A50	S-A41
		5.1	PA10-H-59	PA10-NH-59	PA14-H-59	PA14-NH-59	TB-H-59	TB-NH-59	3D-A59	SB-A51	S-A42
24	Nobel Biocare Replace	3.5	PA10-H-60	PA10-NH-60	PA14-H-60	PA14-NH-60	TB-H-60	TB-NH-60	3D-A60	SB-A52	S-A43
		4.3	PA10-H-61	PA10-NH-61	PA14-H-61	PA14-NH-61	TB-H-61	TB-NH-61	3D-A61	SB-A53	
		5.0	PA10-H-62	PA10-NH-62	PA14-H-62	PA14-NH-62	TB-H-62	TB-NH-62	3D-A62	SB-A54	S-A44
		6.0	PA10-H-63	PA10-NH-63	PA14-H-63	PA14-NH-63	TB-H-63	TB-NH-63	3D-A63	SB-A55	
25	OSSTEM SS	4.8	PA10-H-64	PA10-NH-64	PA14-H-64	PA14-NH-64	TB-H-64	TB-NH-64	3D-A64		S-A45
		6.0	PA10-H-65	PA10-NH-65	PA14-H-65	PA14-NH-65	TB-H-65	TB-NH-65	3D-A65	SB-A56	
26	OSSTEM TS	3.0/3.5	PA10-H-66	PA10-NH-66	PA14-H-66	PA14-NH-66	TB-H-66	TB-NH-66	3D-A66	SB-A57	S-A46
		4.0/4.5/5.0	PA10-H-67	PA10-NH-67	PA14-H-67	PA14-NH-67	TB-H-67	TB-NH-67	3D-A67	SB-A58	S-A47
27	OSSTEM US	3.5	PA10-H-68	PA10-NH-68	PA14-H-68	PA14-NH-68	TB-H-68	TB-NH-68	3D-A68	SB-A59	S-A48
		4.1	PA10-H-69	PA10-NH-69	PA14-H-69	PA14-NH-69	TB-H-69	TB-NH-69	3D-A69	SB-A60	S-A49
		5.1	PA10-H-70	PA10-NH-70	PA14-H-70	PA14-NH-70	TB-H-70	TB-NH-70	3D-A70	SB-A61	S-A50
28	SIC Implant ace/max	3.3	PA10-H-71	PA10-NH-71	PA14-H-71	PA14-NH-71	TB-H-71	TB-NH-71	3D-A71		S-A51
		4.2	PA10-H-72	PA10-NH-72	PA14-H-72	PA14-NH-72	TB-H-72	TB-NH-72	3D-A72	SB-A62	
29	Straumann Bone Level	3.3	PA10-H-73	PA10-NH-73	PA14-H-73	PA14-NH-73	TB-H-73	TB-NH-73	3D-A73	SB-A63	S-A52
		4.1/4.8	PA10-H-74	PA10-NH-74	PA14-H-74	PA14-NH-74	TB-H-74	TB-NH-74	3D-A74	SB-A64	S-A53
30	Straumann Synocta	3.5	PA10-H-75	PA10-NH-75	PA14-H-75	PA14-NH-75	TB-H-75	TB-NH-75	3D-A75	SB-A65	S-A54
		4.8	PA10-H-76	PA10-NH-76	PA14-H-76	PA14-NH-76	TB-H-76	TB-NH-76	3D-A76		S-A55
		6.5	PA10-H-77	PA10-NH-77	PA14-H-77	PA14-NH-77	TB-H-77	TB-NH-77	3D-A77	SB-A66	
31	Straumann Tissue Level	4.8	PA10-H-78	PA10-NH-78	PA14-H-78	PA14-NH-78	TB-H-78	TB-NH-78	3D-A78	SB-A67	S-A56
		6.5	PA10-H-79	PA10-NH-79	PA14-H-79	PA14-NH-79	TB-H-79	TB-NH-79	3D-A79	SB-A68	
32	Thommen SPL Implant	3.5	PA10-H-80	PA10-NH-80	PA14-H-80	PA14-NH-80	TB-H-80	TB-NH-80	3D-A80	SB-A69	S-A57
		4.0	PA10-H-81	PA10-NH-81	PA14-H-81	PA14-NH-81	TB-H-81	TB-NH-81	3D-A81	SB-A70	
		4.5	PA10-H-82	PA10-NH-82	PA14-H-82	PA14-NH-82	TB-H-82	TB-NH-82	3D-A82		S-A58
		5.0	PA10-H-83	PA10-NH-83	PA14-H-83	PA14-NH-83	TB-H-83	TB-NH-83	3D-A83	SB-A71	
		6.0	PA10-H-84	PA10-NH-84	PA14-H-84	PA14-NH-84	TB-H-84	TB-NH-84	3D-A84		
33	Zimmer Tapered Screw-vent	3.5	PA10-H-85	PA10-NH-85	PA14-H-85	PA14-NH-85	TB-H-85	TB-NH-85	3D-A85	SB-A72	
		4.5	PA10-H-86	PA10-NH-86	PA14-H-86	PA14-NH-86	TB-H-86	TB-NH-86	3D-A86	SB-A73	S-A59
		5.7	PA10-H-87	PA10-NH-87	PA14-H-87	PA14-NH-87	TB-H-87	TB-NH-87	3D-A87	SB-A74	



Mediden Implant CAD / CAM Total Solutions

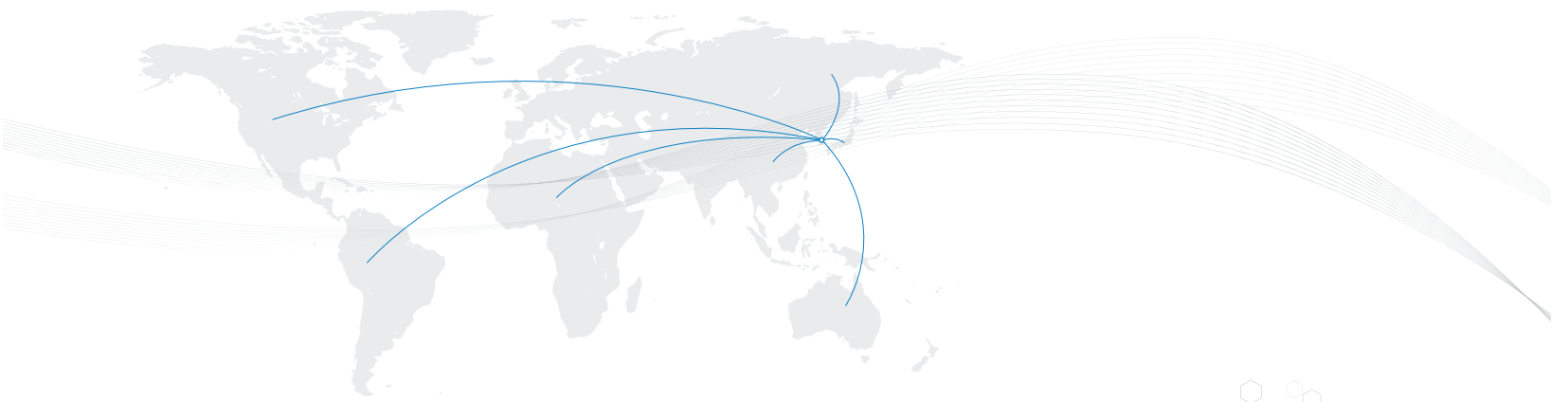

MEDIDEN keeps developing all its product lines with the best quality and precision to its customers worldwide.



(61012) 50, cheomdangwagi-ro 208beon-gil, Buk-gu, Gwangju Republic of Korea
Tel. +82 - 62-973 - 8287 Fax. +82-62-443-4752
E-mail. medi@mediden.kr www.mediden.kr